

The LEGO logo is positioned in the top left corner, featuring the word "LEGO" in white, bold, sans-serif font with a black outline, set against a red square background.

BIONICLE

71305



LEGO.com/bionicle



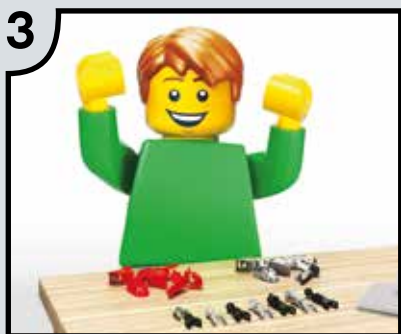
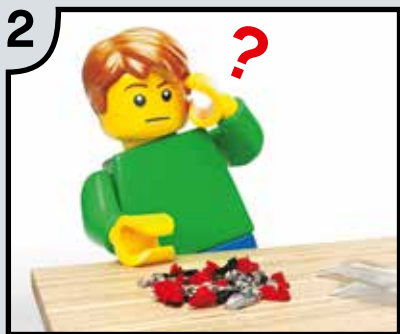

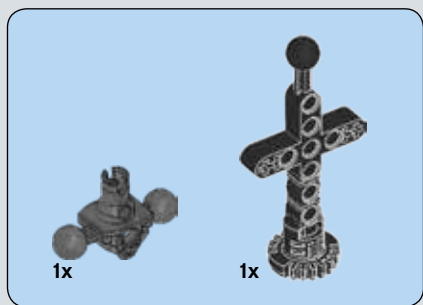

1

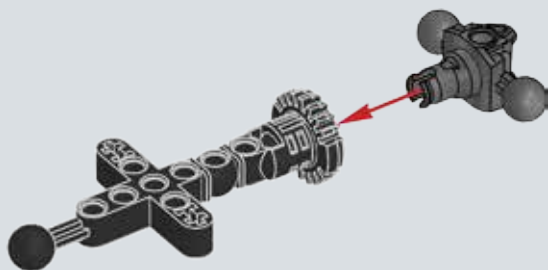

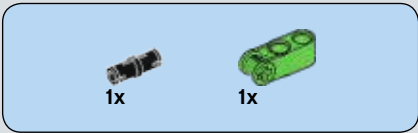

2

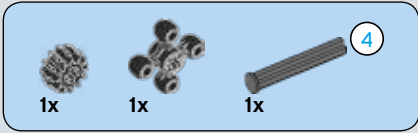
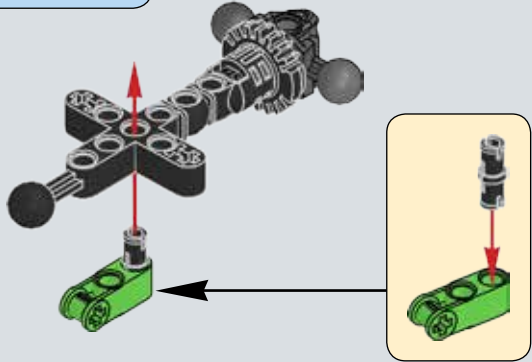

3

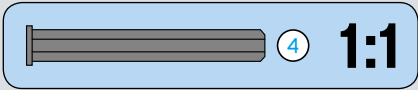
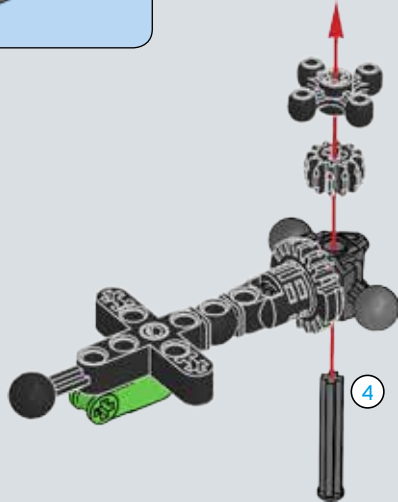



2x

4

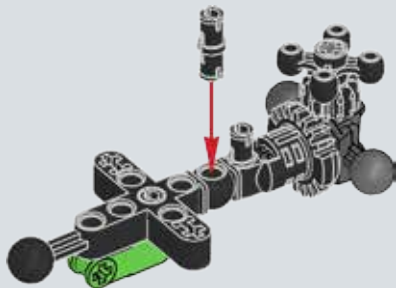

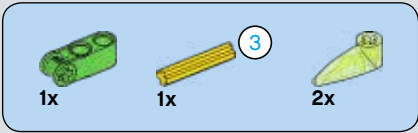

5

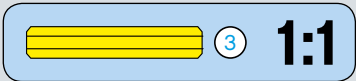
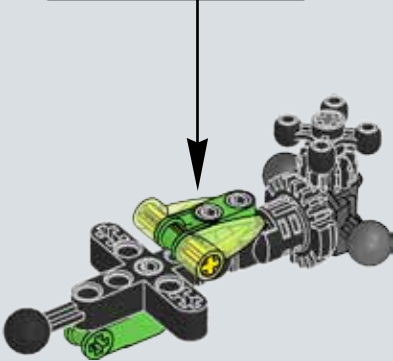
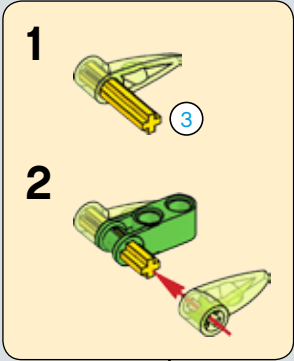

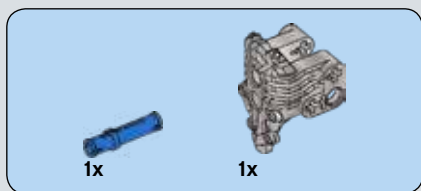

6

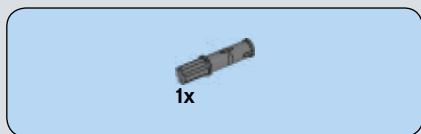
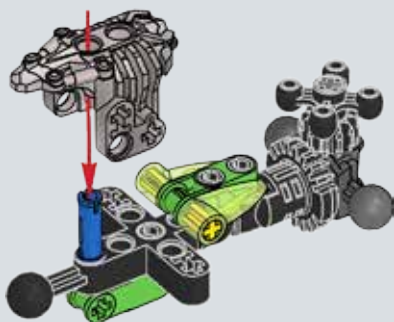

7

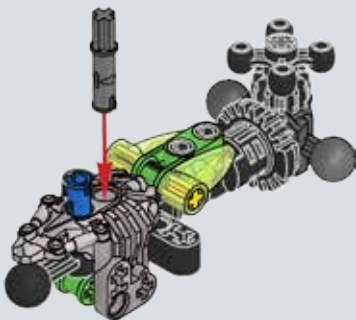

8

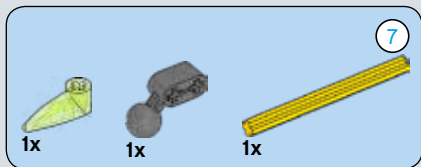

8

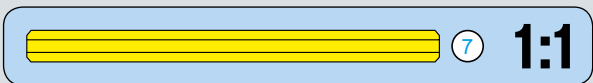
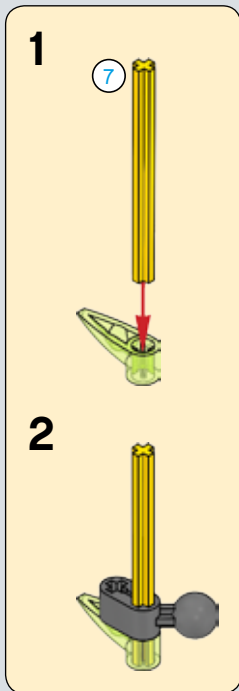
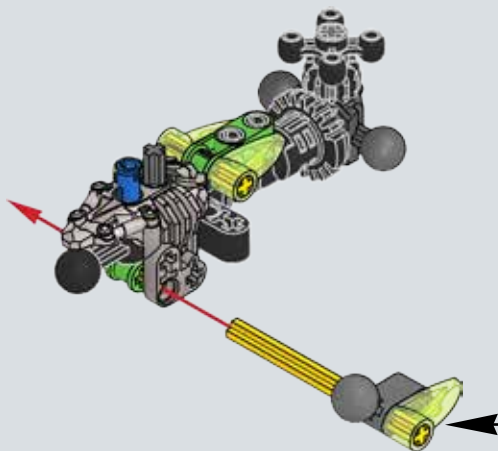



1x



1x

9

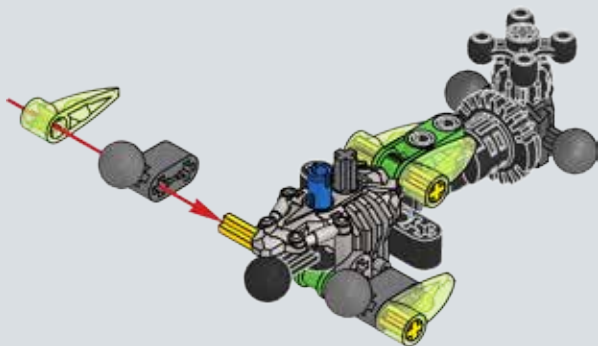



2x



1x



1x

10

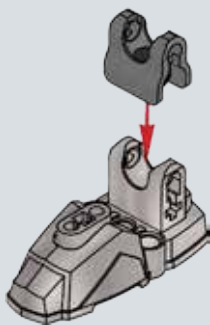

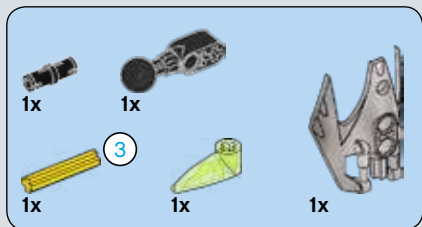

11

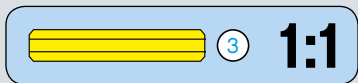
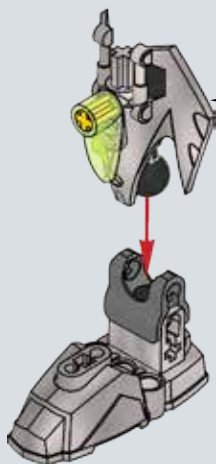
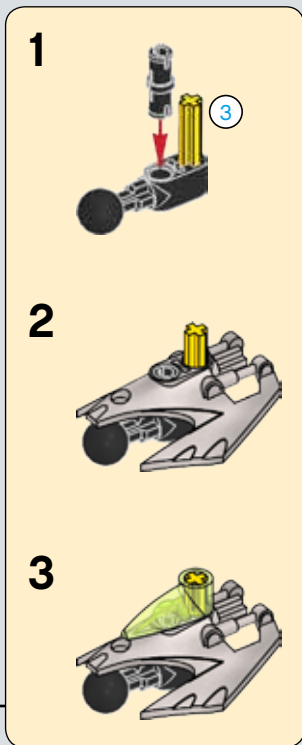



12

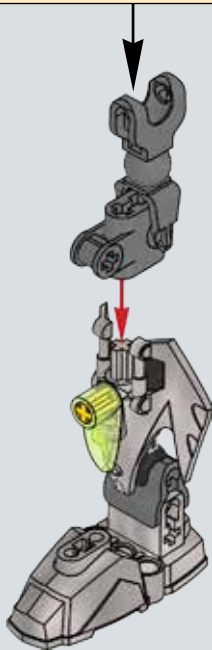
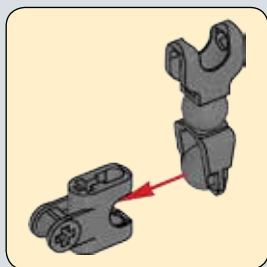



1x

13

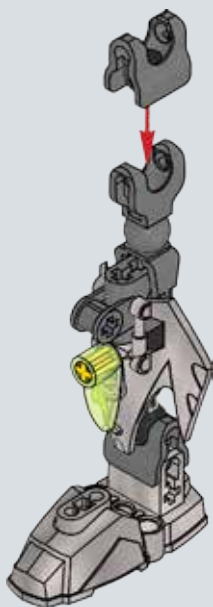

2x

14

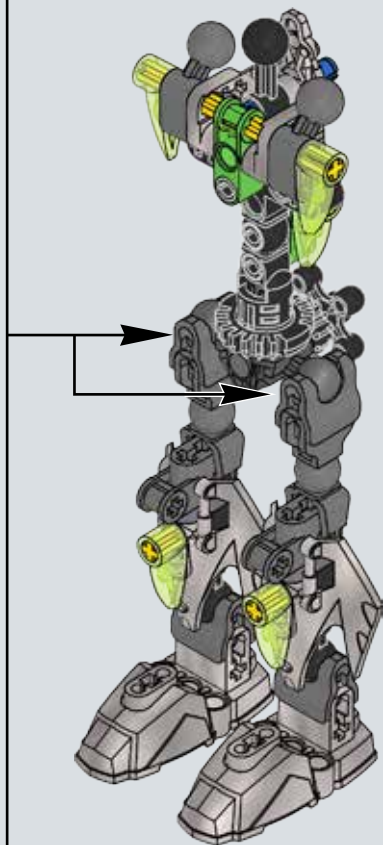



2x

15

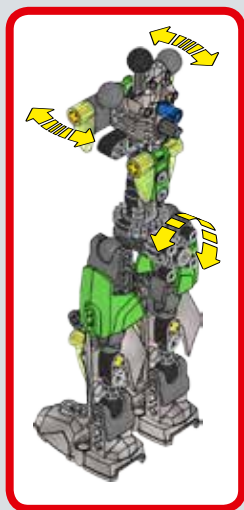
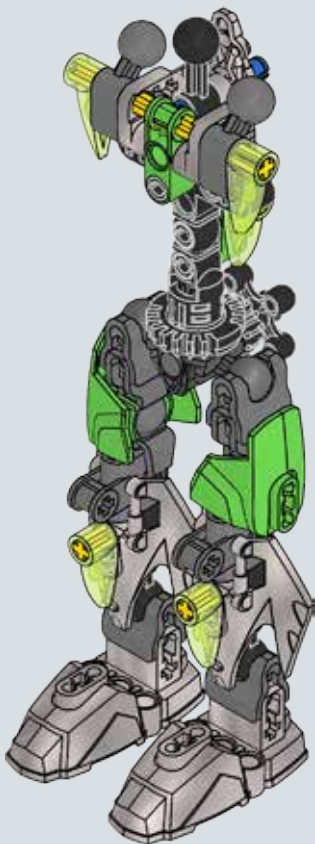

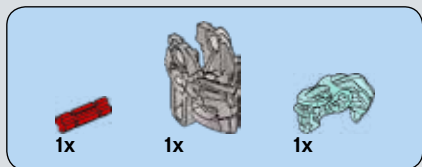

16

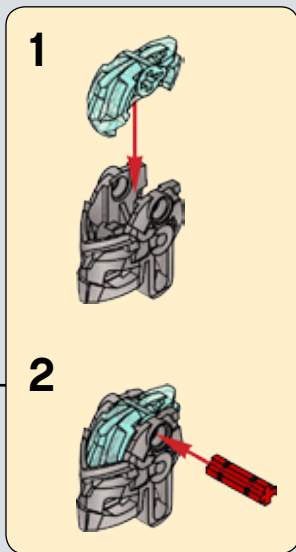
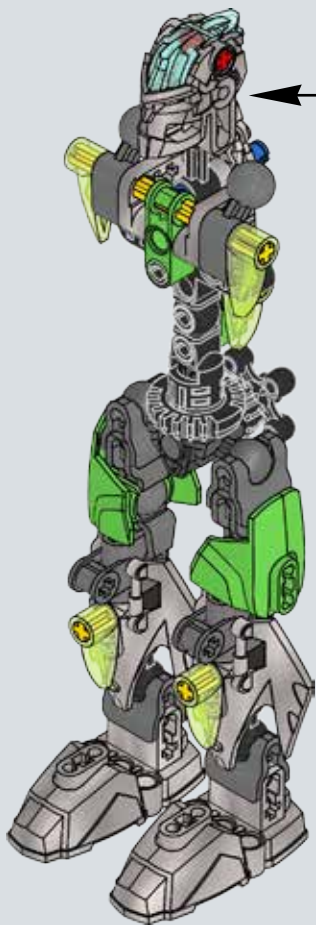

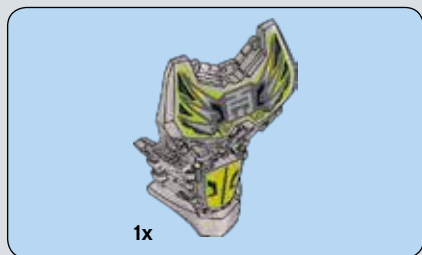

17

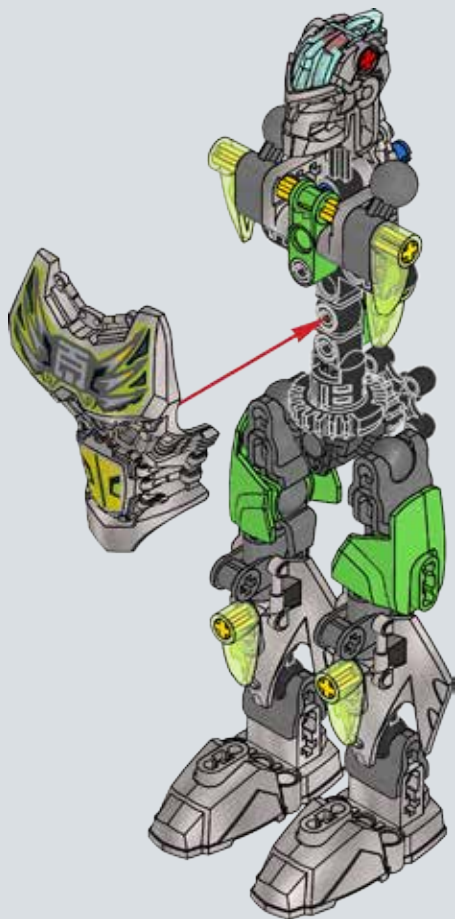

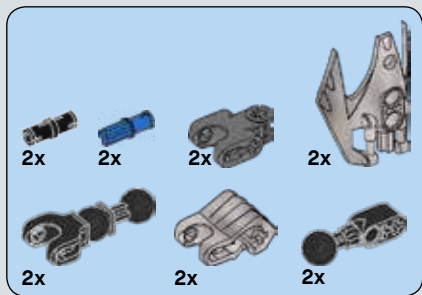

18

1

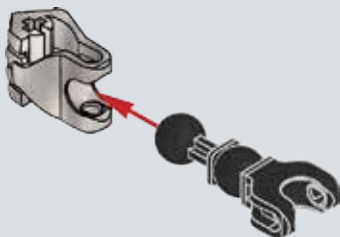

2

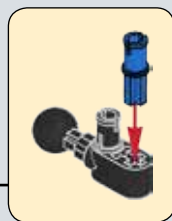
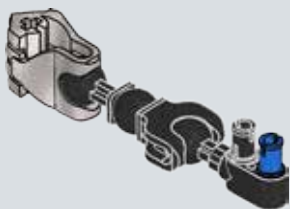

3

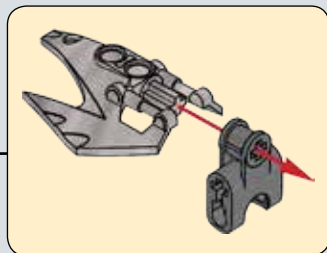
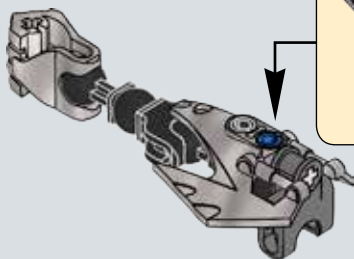

2x

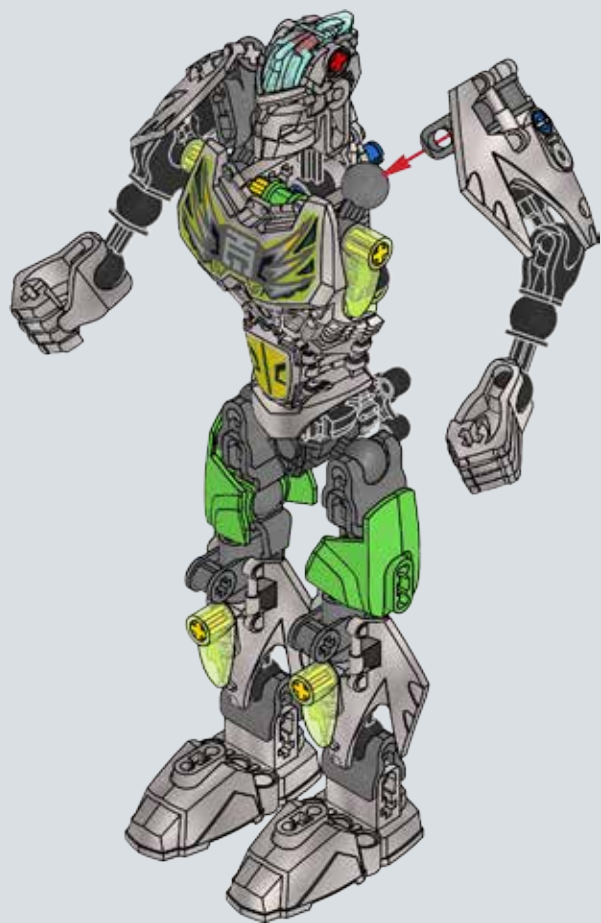

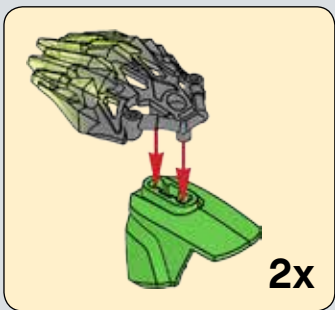

19

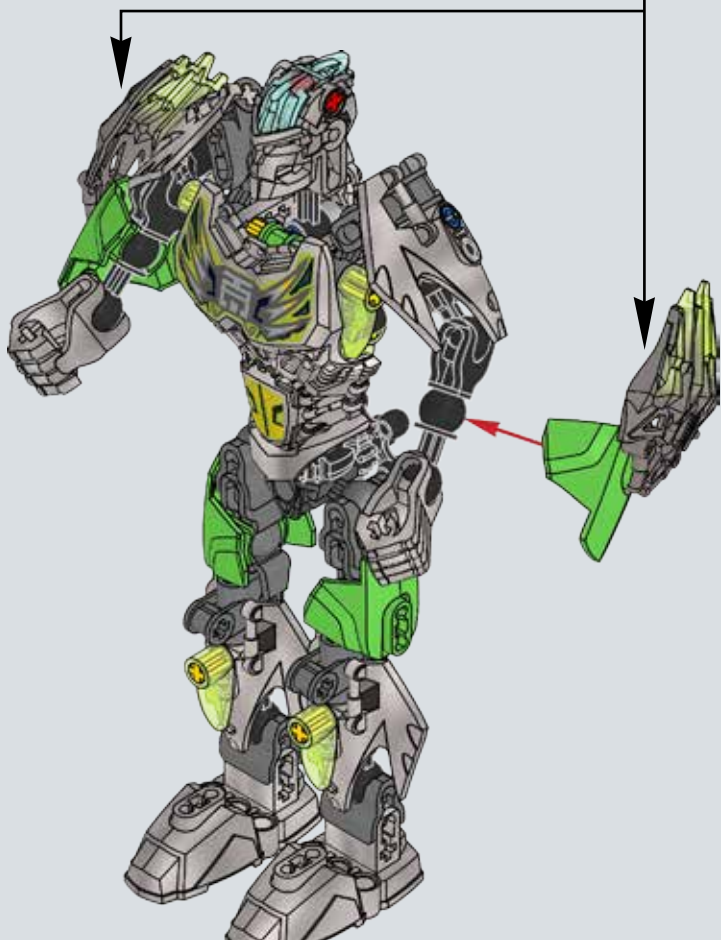

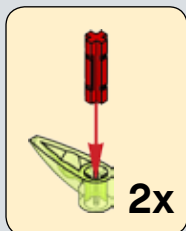
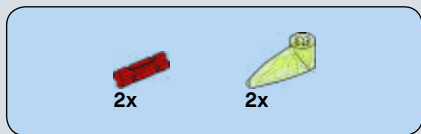

20

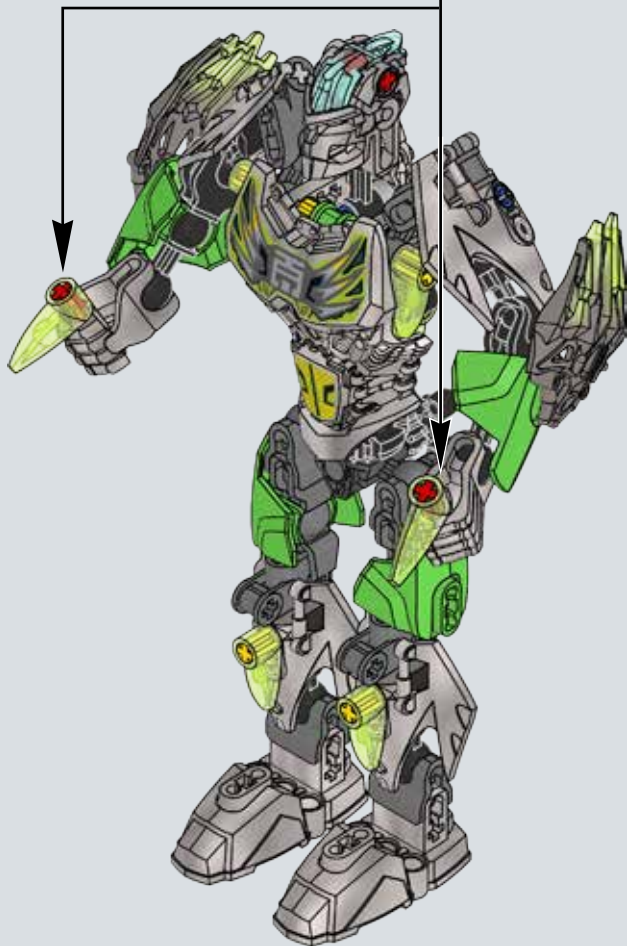

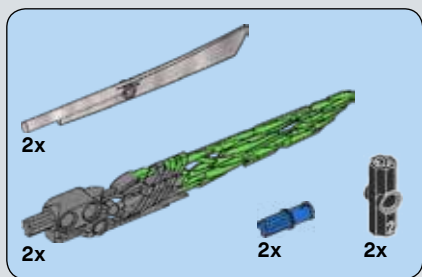

21

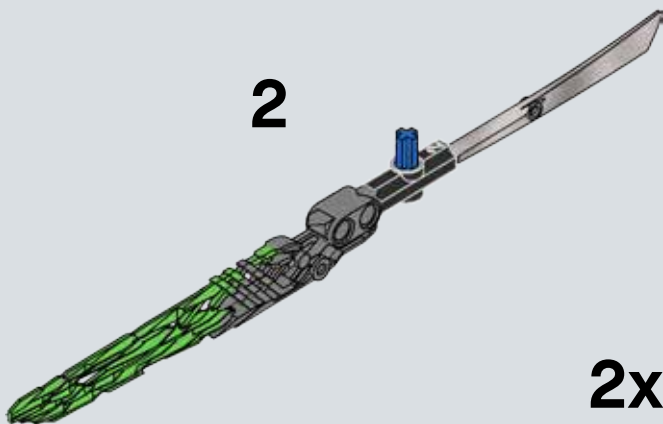
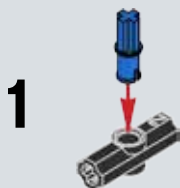

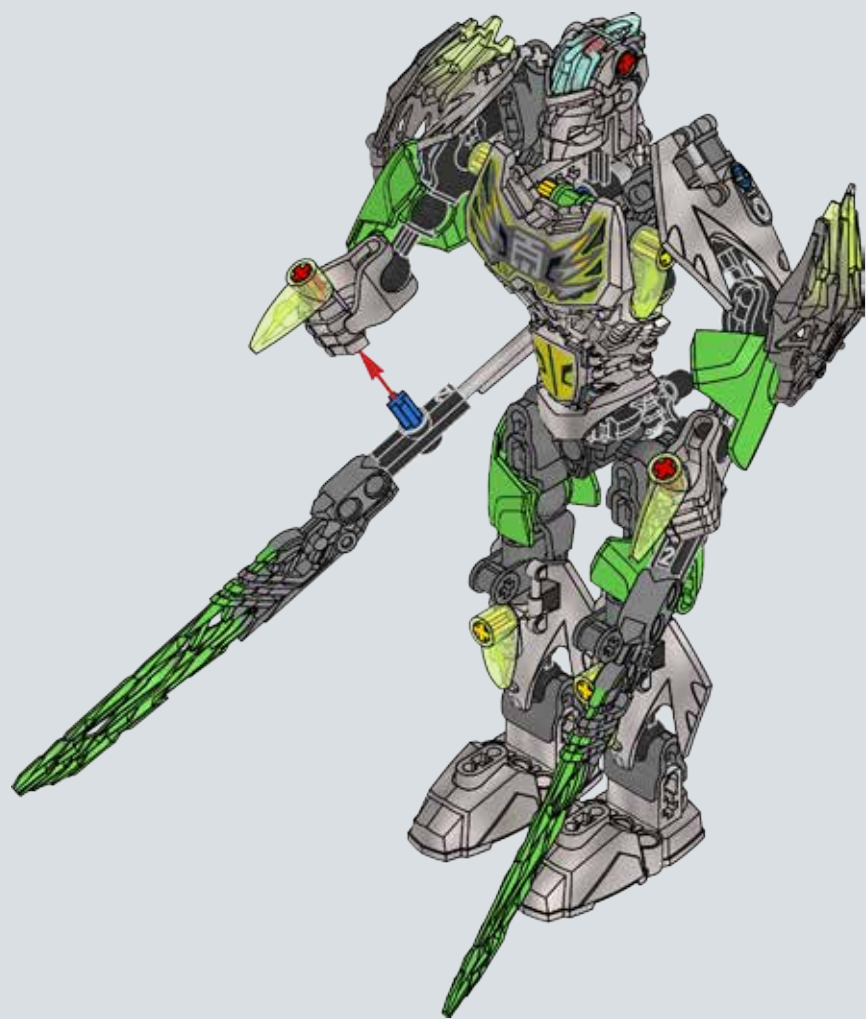

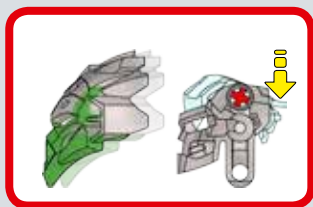

22

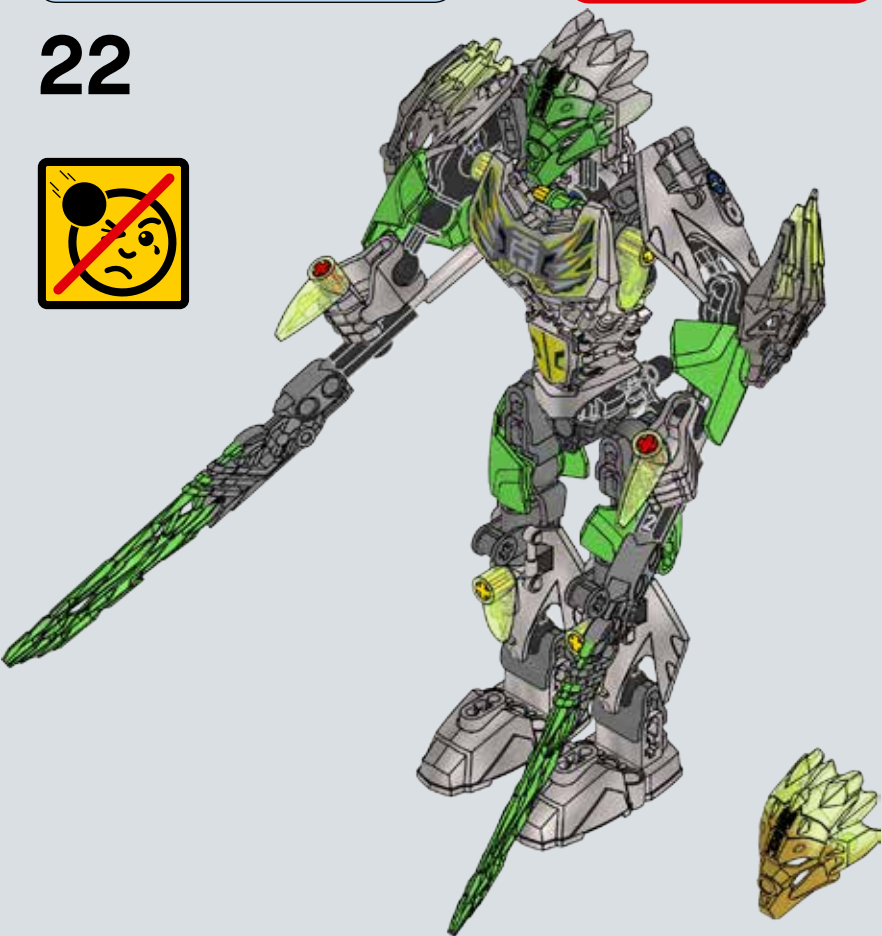

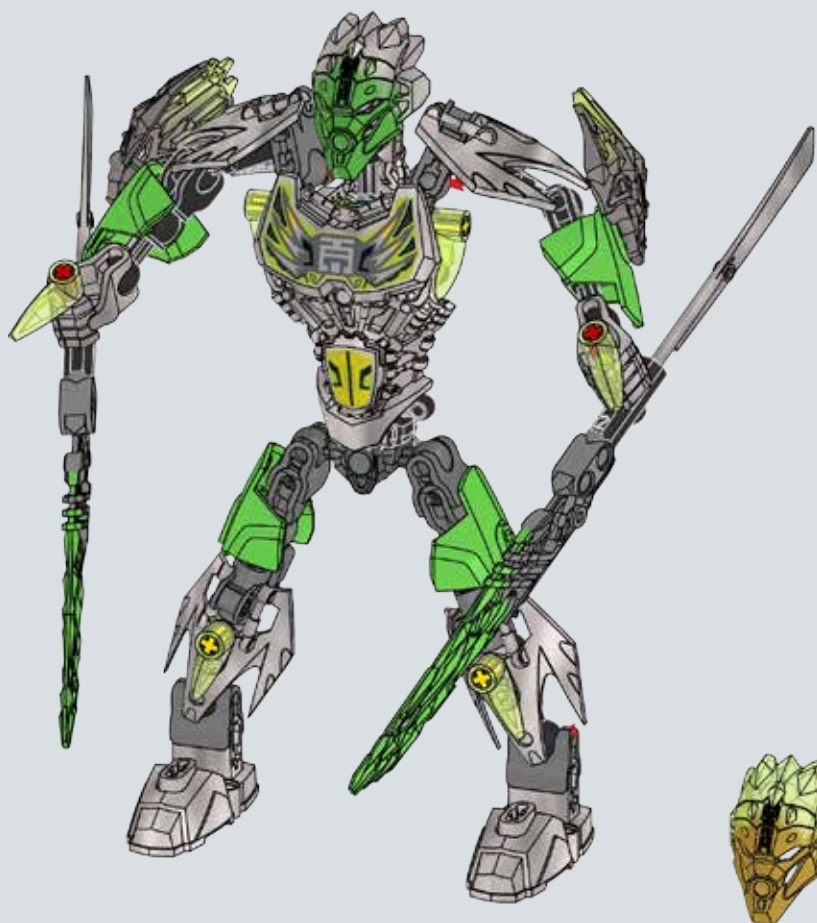

3x
4142865

4x
4206482

1x
4514553

3x
6130007

1x
6130009

2x
4107783

1x
4177431

7x
4121715

1x
4248204

2x
4593555

4x
4560108

1x
6135125

4x
6106472

1x
6015356

2x
4289258

4x
4626667



1x
6083620

2x
4622903

1x
6102606

4x
6016585

2x
4619077

1x
6135031

1x
6135237

1x
6135599

1x
6135238

8x
6133135

4x
6108829

2x
6097398



2x
6135119

1x
6135032

2x
4632585

1x
6139106

2x
4654422

2x
6150661



Customer Service

Kundenservice

Service Consommateurs

Servicio Al Consumidor

LEGO.com/service or dial



00800 5346 5555 :



1-800-422-5346 :



LEGO

BIONICLE

71310



UNITE for battle



71300+71305



LEGO.com/bionicle

UNIS-LES pour le combat
Sólo podemos luchar UNIDOS

Download App
Télécharger l'application
Descarga la App



NETFLIX



Download on the
App Store

Apple, the Apple logo, iPad, iPhone and iPod touch are trademarks of Apple Inc.
Apple, le logo Apple, iPad, iPhone et iPod touch sont des marques de commerce d'Apple Inc.
Apple, el logotipo de Apple, iPad, iPhone e iPod touch son marcas comerciales de Apple Inc.

GET IT ON

Google play

Google Play is a trademark of Google Inc.
Google Play est une marque de commerce de Google Inc.
Google Play es una marca comercial de Google Inc.



71300



71305



71301



71306



71302



71307



71303



71308



71304



71309



71311



71311





71311

71302

71301

71311

71307

71306



71303



71300



71304



71308



71305



71309

